

**Burner Systems:**

- EC-36-10(M)(P)
- EC-48-10(M)(P)
- EC-60-10(M)(P)

**Log Sets:**

- MP-(36,48,60)
- Mammoth Pine

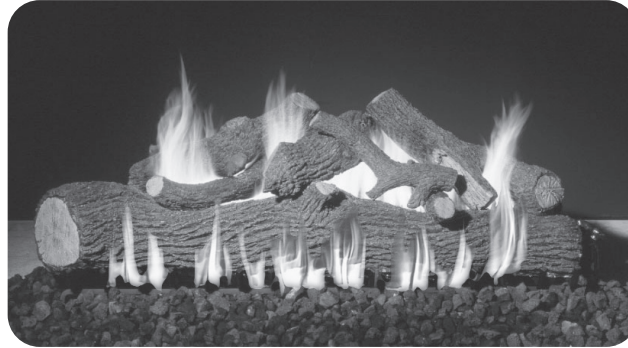

**COMPLIES to applicable ANSI standards for Vented Decorative Appliances**

**FOR INSTALLATION IN SOLID-FUEL BURNING FIREPLACES\***

**EPIC VENTED GAS LOG SETS**

**WARNING**

If the information in this manual is not followed exactly, a fire or explosion may result, causing property damage, personal injury, or loss of life.

**Do not store or use gasoline or other flammable vapors and liquids in the vicinity of this or any other appliance.**

**WHAT TO DO IF YOU SMELL GAS:**

- Open a window.
- Do not try to light any appliance.
- Do not touch any electrical switch; do not use any phone in the building.
- Immediately call the gas supplier from a neighbor's phone. Follow gas supplier's instructions.
- If you cannot reach the gas supplier, call the fire department.

**Installation and service must be performed by a qualified professional service technician, service agency, or the gas supplier.**

**This appliance is only for use with the type of gas indicated on the rating plate.**

**IMPORTANT: READ THESE INSTRUCTIONS CAREFULLY BEFORE STARTING INSTALLATION OF THE UNIT.**

The Real Fyre gas log set is to be installed only in a solid-fuel burning fireplace with a working flue and constructed of noncombustible material. The installation, including provisions for combustion and ventilation air must conform with the National Fuel Gas Code, ANSI Z223.1/NFPA 54, or the CSA B149.1, Natural Gas and Propane Installation Code, and applicable local building codes.

A damper clamp is included to maintain the minimum permanent vent opening and to prevent full closure of the damper blade. **The chimney damper MUST be fully opened when burning the unit. The unit is designed to burn with yellow flames; thus adequate ventilation is absolutely necessary.**

To comply with certification, listings, and building code acceptances, and for safe operation and proper performance of this gas log set, you must use ONLY Peterson Real Fyre parts, decorative media, and accessories. Use of any other controls, parts, or accessories not designed for use with Real Fyre gas log sets is prohibited. This will void all warranties, certifications, listings, and building code approvals, and may cause property damage, personal injury, or loss of life. Peterson will not be liable for any damages caused by this misuse.

**\*Note:** Solid-fuels shall not be burned in a fireplace where a decorative appliance is installed.



We recommend that our gas hearth products be installed and serviced by professionals who are certified in the U.S. by the National Fireplace Institute® (NFI) as NFI Gas Specialists.

**INSTALLER:**

**Leave this manual with the appliance.**

**CONSUMER:**

**Retain this manual for future reference.**

# TABLE OF CONTENTS

## GETTING STARTED

IMPORTANT PRE-INSTALLATION AND FIREPLACE SAFETY INFORMATION.....	3
FIREPLACE OPERATING SAFETY INFORMATION.....	4
SPECIFICATIONS.....	5
<i>ASH LIP/RECESS REQUIREMENTS (if applicable)</i> .....	5
<i>GLASS DOOR REQUIREMENTS</i> .....	6
DAMPER CLAMP INSTRUCTIONS .....	8
EPIC BURNER PARTS LIST - 10 SERIES .....	9
LOGS PARTS LIST.....	10

## INSTALLATION

INSTALLATION.....	12
<i>BURNER INSTALLATION</i> .....	12
<i>HEAT SHIELD PLACEMENT</i> .....	13
<i>LIGHTING TEST</i> .....	13
<i>LAVA COALS</i> .....	13
<i>LOG SET PLACEMENT</i> .....	14
INSTALLING/REPLACING BATTERIES (IF APPLICABLE).....	16
<i>REMOTE TRANSMITTER BATTERY</i> .....	16
<i>REMOTE RECEIVER BATTERIES</i> .....	16

## USE, CARE, & SERVICE

LIGHTING INSTRUCTIONS - SERIES 10 VALVE .....	17
CLEANING AND SERVICING .....	18
<i>SYNCING THE REMOTE SYSTEM (if applicable)</i> .....	19
<i>ADJUSTING AIR SHUTTERS</i> .....	19
FLAME DESCRIPTION .....	19
TROUBLESHOOTING.....	20
WARRANTY .....	22

## IMPORTANT PRE-INSTALLATION AND FIREPLACE SAFETY INFORMATION

**CAUTION:** Installation and repair must be done by an NFI Certified or other qualified professional installer.

**Installer:** Carefully read these instructions before installing this gas burner system. Be sure you understand all safety precautions and warnings contained in this manual.

- A. **BE CAREFUL:** If not installed, serviced, and used correctly per these instructions, this product can cause serious personal injury, property damage, or loss of life.
- B. **A shut-off valve (not included) in the gas supply line is required.** It must be installed upstream of the unit and must be easily accessible. The shut-off valve cannot be located in the fireplace firebox. Refer to the NFPA 54 guidelines for further details.
- C. A sediment trap in the gas supply line is recommended where applicable. It should be installed downstream of the shut-off valve as close to the unit as possible. Refer to the NFPA 54 guidelines for further details.
- D. **WARNING:** When installing in a solid-fuel-burning fireplace, **the chimney flue, damper, and firebox must be thoroughly CLEANED** of soot, creosote, ashes, and loose paint, and must be inspected by a qualified chimney cleaner. Some older fireplaces may need repair prior to installing this appliance.
- E. The fireplace floor must be level and smooth.
- F. This appliance is only for use with the type of gas indicated on the rating plate. This appliance is **NOT FIELD CONVERTIBLE** for use with other gasses.

CHECK GAS TYPE (natural or L.P.): The gas supply must be the same as stated on your burner system rating plate. If gas supply is different, **DO NOT INSTALL**. Contact your dealer for immediate assistance.

- G. **INSUFFICIENT GAS PRESSURE WILL KEEP THE PILOT (IF EQUIPPED) FROM OPERATING PROPERLY. DO NOT USE IF GAS PRESSURE IS LOWER THAN THE MINIMUM REQUIREMENT.**
- H. The *minimum* inlet gas-supply pressure for purposes of input adjustment is **5"** water column (w.c.) on **natural gas** and **11"** w.c. on **L.P. gas**. Insufficient gas pressure will affect proper operation of the unit. Do not install this gas appliance if minimum pressure is not available. The *maximum* inlet gas-supply pressure is **10.5"** w.c. on natural gas and **13"** w.c. on L.P. gas. **The L.P. source must be regulated, located outside, and hard-lined in (rigid pipe must come into the fireplace). DO NOT connect this appliance to an unregulated L.P. gas tank/cylinder. DO NOT locate the tank/cylinder inside of the home. DO NOT run a rubber hose or flex connector into the fireplace. Failure to follow these requirements can cause an explosion, property damage, personal injury, or loss of life.**
- I. **The gas piping system must be sized to provide minimum inlet pressure at the maximum flow rate (BTU/hr).** Undue pressure loss will occur if the pipe is too small, or the run is too long. Gas supply pipe must be 1/2" minimum interior diameter. If the gas line is longer than 20', a larger diameter line may be necessary. Refer to the NFPA 54 guidelines for further details.
- J. Input ratings shown in BTU per hour are for elevations up to 2,000 ft. For elevations above 2,000 ft., refer to the National Fuel Gas Code or contact manufacturer before installing this product.
- K. This gas appliance and its main gas valve must be disconnected from the gas-supply piping system during any pressure testing of that system at test pressures in excess of 1/2 psig.
- L. This gas appliance must be isolated from the gas-supply piping system by closing the gas supply shutoff valve during any pressure testing of the gas-supply piping system at test pressures equal to or less than 1/2 psig.
- M. **To install the gas appliance in your fireplace, the fireplace MUST meet the minimum size requirements (see product specifications table in SPECIFICATIONS section).**
- N. This appliance may be installed in an aftermarket, permanently located, manufactured (mobile) home, where not prohibited by local codes. Installation of appliances designed for manufactured home (U.S. only) or mobile home installation must conform with the Standard CAN/CSA Z240 MH, Mobile Housing, in Canada, or with the Manufactured Home Construction and Safety Standard, Title 24 CFR, Part 3280, in the United States, or when such a standard is not applicable, ANSI/NCSBCS A225.1/NFPA 501A, Manufactured Home Installations Standard.
- O. **DO NOT install this burner system in a fireplace with an ash lip or recess greater than 3/4".**
- P. If this burner system is installed in a fireplace with **glass doors**, and the doors have a frame that obstructs airflow to the fireplace floor, the frame **MUST** have slots (above the fireplace floor) that allow adequate ventilation. The opening (with doors fully open) **MUST** meet the minimum fireplace size front width and height requirements. The glass doors **MUST** be fully open when the burner is in operation. See the SPECIFICATIONS section for details.

## FIREPLACE OPERATING SAFETY INFORMATION

- A. Adults **MUST** be present when this gas appliance is operating. This appliance **MUST NOT** be left burning when unattended or while anyone is sleeping.
- B. Keep the area of the gas burner system clear and free from combustible materials, gasoline, and other flammable vapors and liquids.
- C. DO NOT use this appliance if any part has been underwater. Immediately call a qualified service technician to inspect the appliance and to replace any part of the control system and any gas control that has been underwater. Attempted operation may result in fire or explosion resulting in property damage, personal injury or loss of life.
- D. **A fireplace screen must be in place when the system is burning.** Provisions for adequate combustion air must be maintained. Unless other provisions for combustion air are provided, the screen shall have an opening(s) for introduction of combustion air. Combustion air is adequate when all flames curl into the fireplace and away from the screen. **When a glass fireplace enclosure (door) is used, the glass doors MUST be fully open when the burner is in operation.**
- E. Do not remove the rating plates or the warning tags. These are an integral safety and identification component of this appliance.
- F. Be sure to read the CLEANING AND SERVICING and FLAME DESCRIPTION sections.

# SPECIFICATIONS

Real Fyre gas burner systems must be installed only in a wood burning fireplace with the minimum firebox dimensions and venting requirements met (see following tables). This appliance is designed to burn with yellow flames; adequate ventilation is absolutely necessary.

## Product Specifications

Model	Minimum Fireplace Size				BTU Rating	
	Width *		Depth ‡	Height	Nat. Gas	L.P. Gas
	Front	Rear †				
EC-36	48"	41"	18"	36"	100k	100k
EC-48	62"	56"	24"	36"	145k	145k
EC-60	72"	65"	24"	36"	260k	190k

### Important Information Regarding Dimensions

\* These required widths allow for centering of the unit.

† Rear width is at corresponding depth.

‡ If an ash lip exists, the depth requirement begins inside of the lip (see Fig. 5-1 below).

**Table 1 - Product Specifications**

Specification	Value	Qty.
Remote transmitter battery type	12V battery	1
Remote receiver battery type	AA battery	4

**Table 2 - Technical Data (if applicable)**

## ASH LIP/RECESS REQUIREMENTS (if applicable)

- DO NOT install this burner system in a fireplace with an ash lip or recess greater than 3/4".
- The depth (as indicated in the chart above) begins inside of the lip.

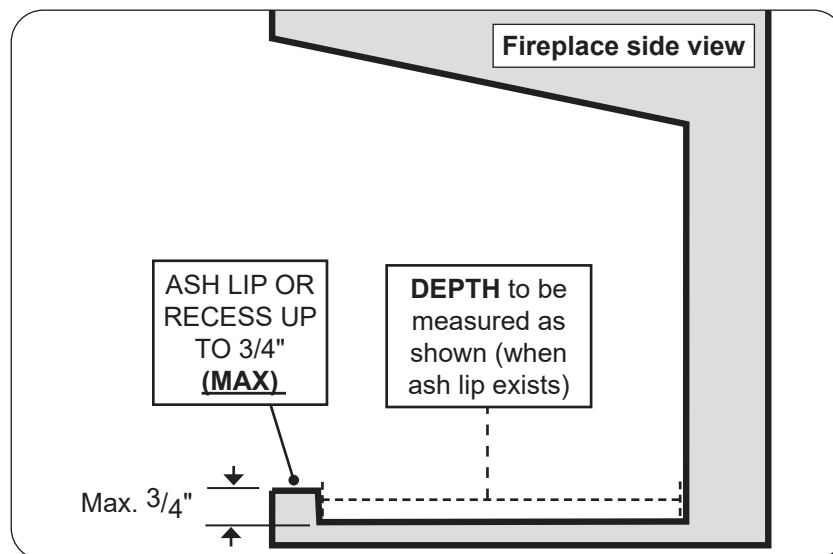

**Fig. 5-1 Ash lip/recess detail**

## GLASS DOOR REQUIREMENTS

If this burner system is installed in a fireplace with glass doors, and the door frame bottom is greater than 3/4" in height, the frame MUST have slots (above the fireplace floor) that allow adequate ventilation. This prevents airflow obstruction (to the fireplace floor). See Fig. 6-1.

**Note:** The doors can be installed in front of an ash lip (that meets the requirements on the previous page).

**Important:** The opening (with doors fully open) MUST meet the minimum fireplace size front width and height requirements. See the Table on the previous page and Fig. 6-1.

**Important:** The glass doors MUST be fully open when the burner is in operation.

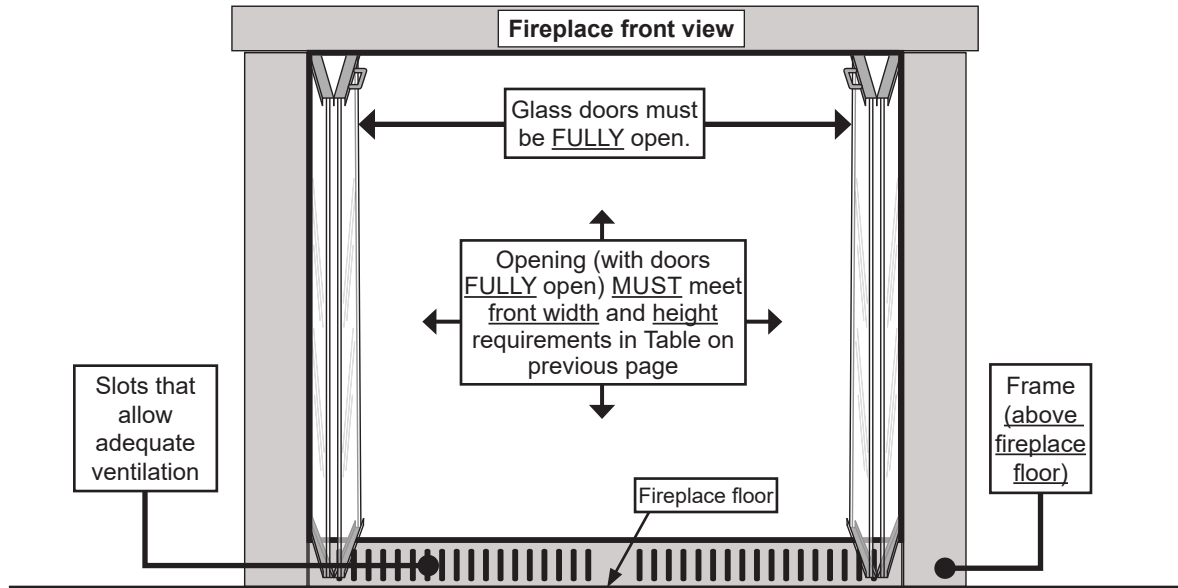

**Fig. 6-1** Correct glass-doors frame setup, ventilation, and use (if applicable)

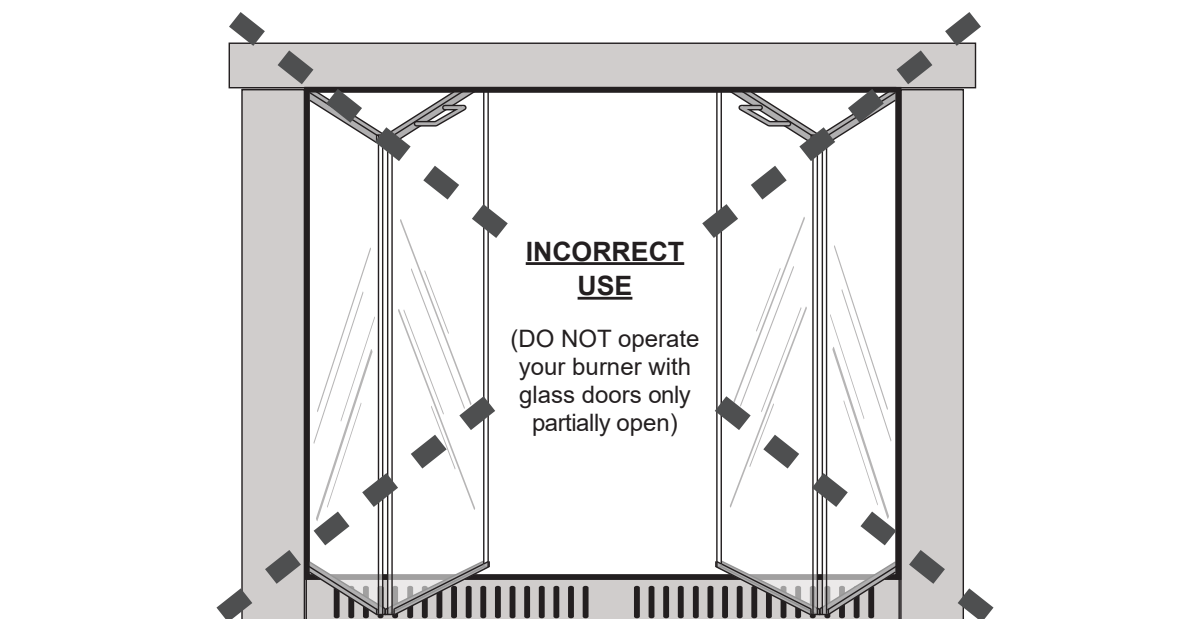

**Fig. 6-2** Incorrect glass-doors frame setup, ventilation, and use (if applicable)

10 SERIES WIRING DIAGRAM

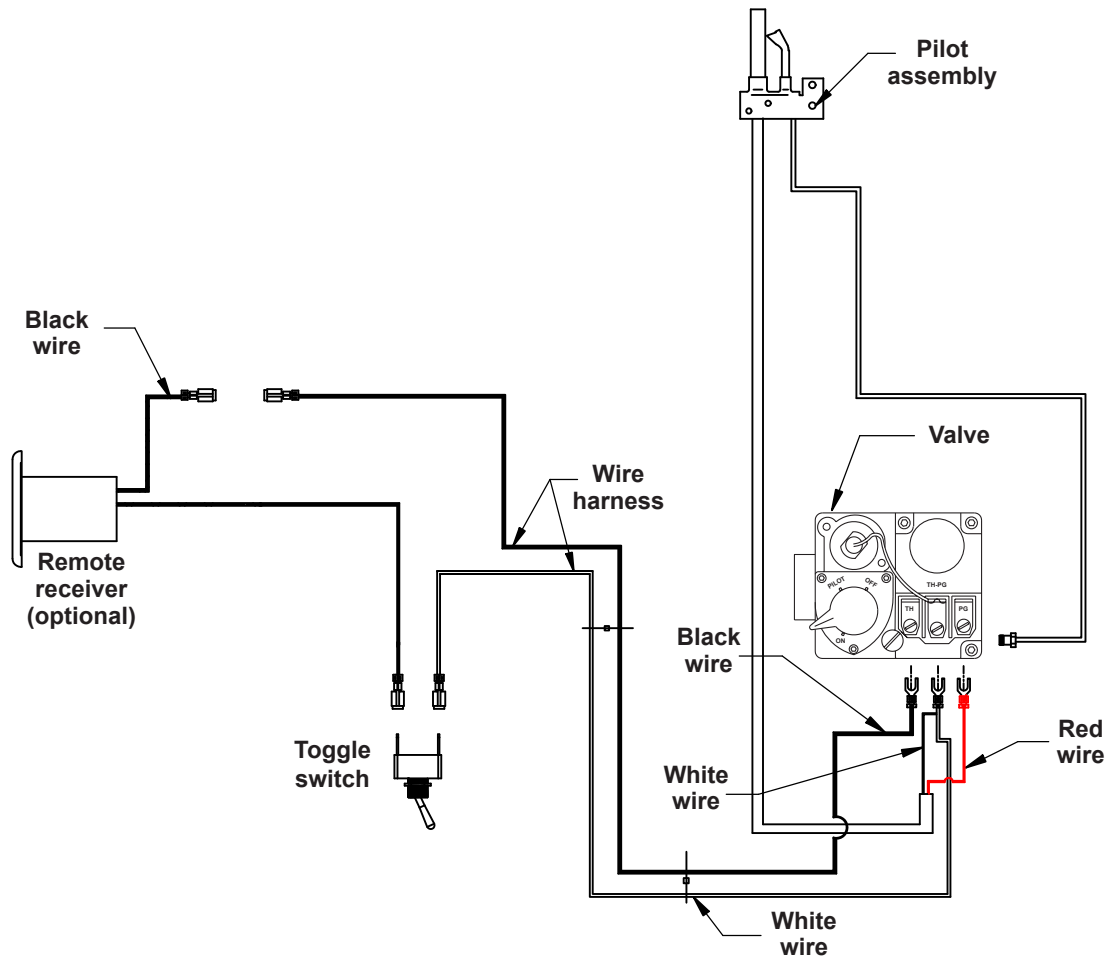
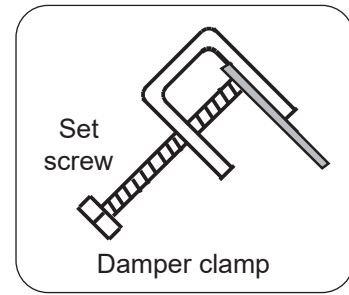

Fig. 7-1

# DAMPER CLAMP INSTRUCTIONS

The damper clamp with hex bolt (Fig. 8-1) is provided as a means to prevent full closure of the damper blade. The clamp is easily attached to most damper blades with pliers or a wrench, and must be permanently installed. The clamp is designed to prevent accidental closure of the damper when installed as illustrated (Fig. 8-2). Should the clamp not fit, or fail to provide the permanent vent opening listed in Table 3 below, have a permanent stop installed, remove the damper blade, or have the damper cut to provide the minimum permanent opening required.



**Fig. 8-1** Damper clamp detail

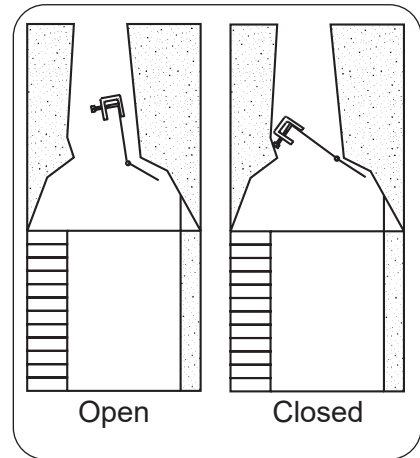

**Fig. 8-2** Damper open / closed

## Venting Requirements

**Note: The minimum chimney height from hearth to top of chimney is 15'.**

Minimum permanent free opening area of chimney damper for venting (sq. in.)			
For factory-built fireplaces			
Chimney height	36"	48"	60"
15'	47	74	136
20'	43	66	128
30'	34	57	119
For masonry-built fireplaces			
15'	60	84	146
20'	54	76	138
30'	49	67	129

**Table 3 - Minimum Chimney Damper Vent Opening Requirements**

**THESE ARE MINIMUM DAMPER OPENING SPECIFICATIONS.**

**THE DAMPER MUST BE COMPLETELY OPENED WHEN OPERATING THIS GAS APPLIANCE TO ACHIEVE THE BEST VENTILATION POSSIBLE.**



# EPIC BURNER PARTS LIST - 10 SERIES

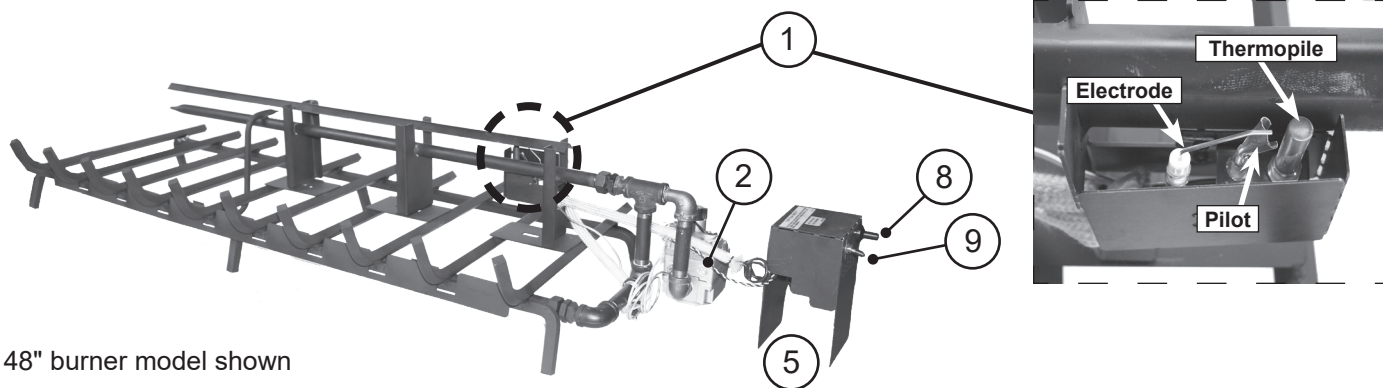

48" burner model shown

**DO NOT REMOVE  
HEAT SHIELD**

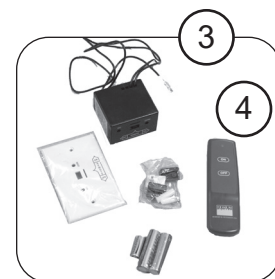
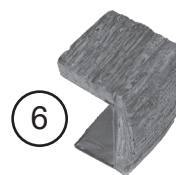

**Note: Photos not to scale**

**Replacement parts can be ordered  
from your local Real Fyre dealer.**

Item	Description	36" model		48" model		60" model	
		Part No.	Qty.	Part No.	Qty.	Part No.	Qty.
1.	Pilot assembly (natural) or Pilot assembly (propane)	PAC-19 PAC-19P	1 1	PAC-19 PAC-19P	1 1	PAC-19 PAC-19P	1 1
2.	Control valve (natural or propane)	SV-5	1	SV-5	1	SV-5	1
3.	Remote kit * † (includes receiver, transmitter, batteries, plastic cover)	RR-1A	1	RR-1A	1	RR-1A	1
4.	Remote transmitter (only) *	AT-R1-1	1	AT-R1-1	1	AT-R1-1	1
5.	Valve heat shield	HS-53	1	HS-53	1	HS-53	1
6.	Decorative heat shield * †	HS-36	1	HS-36	1	HS-36	1
7.	Flex connector (w/ adapter), 1/2" O.D. x 24"	CK-5-24-SP	1	CK-5-24-SP	1	CK-5-24-SP	1
8.	Piezo igniter	PZ-1	1	PZ-1	1	PZ-1	1
9.	Toggle switch	SW-2	1	SW-2	1	SW-2	1
10.	Damper clamp	DC-1	1	DC-1	1	DC-1	1

\* if equipped

† to add a remote system to a 10M model, use RR-1A and HS-36

# LOGS PARTS LIST

**Note:** The log set is purchased and packaged separately; contact your local dealer when ordering.

## MP-36 PARTS LIST

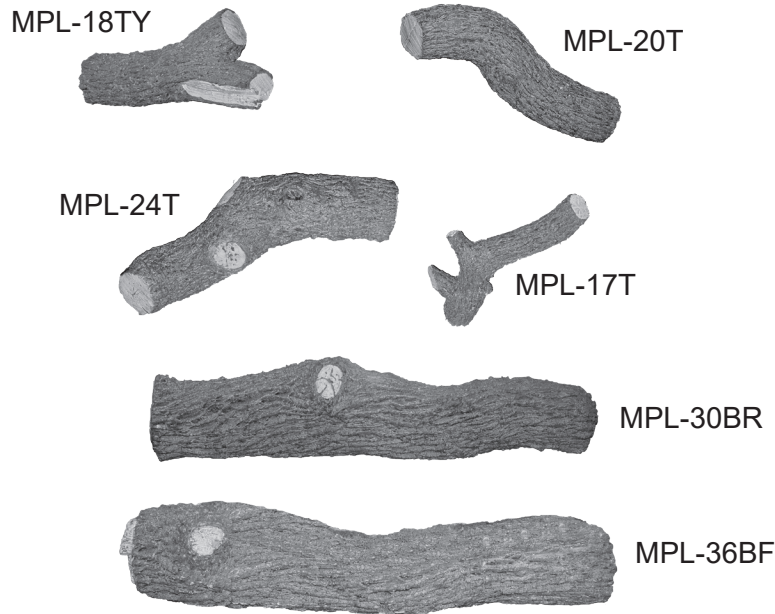

## MP-48 PARTS LIST

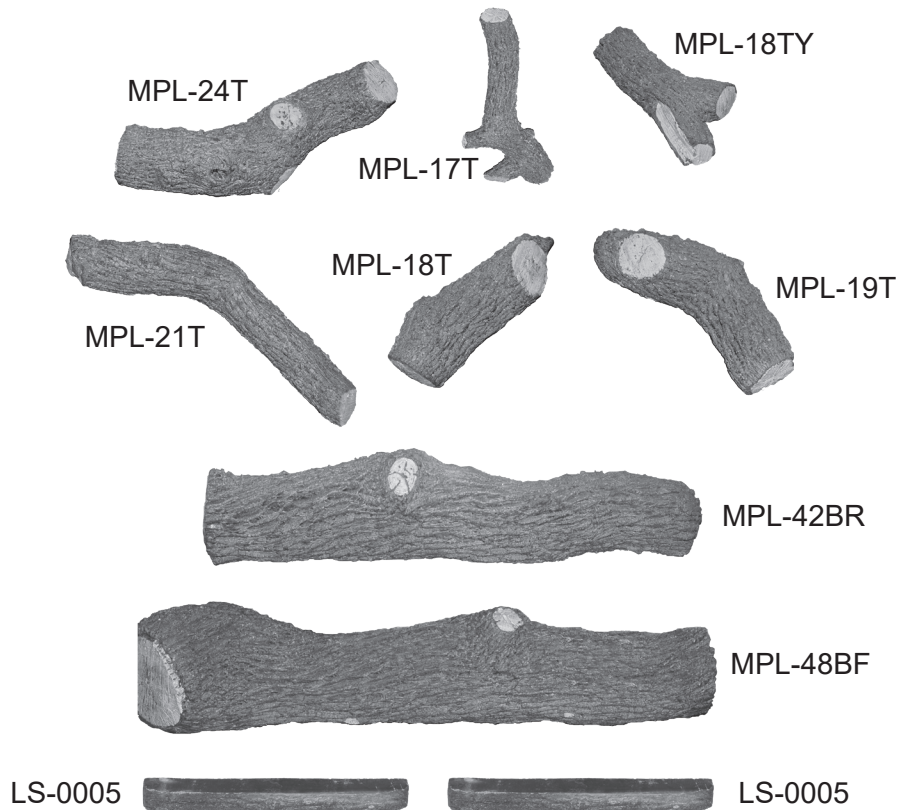

**MP-60  
PARTS LIST**

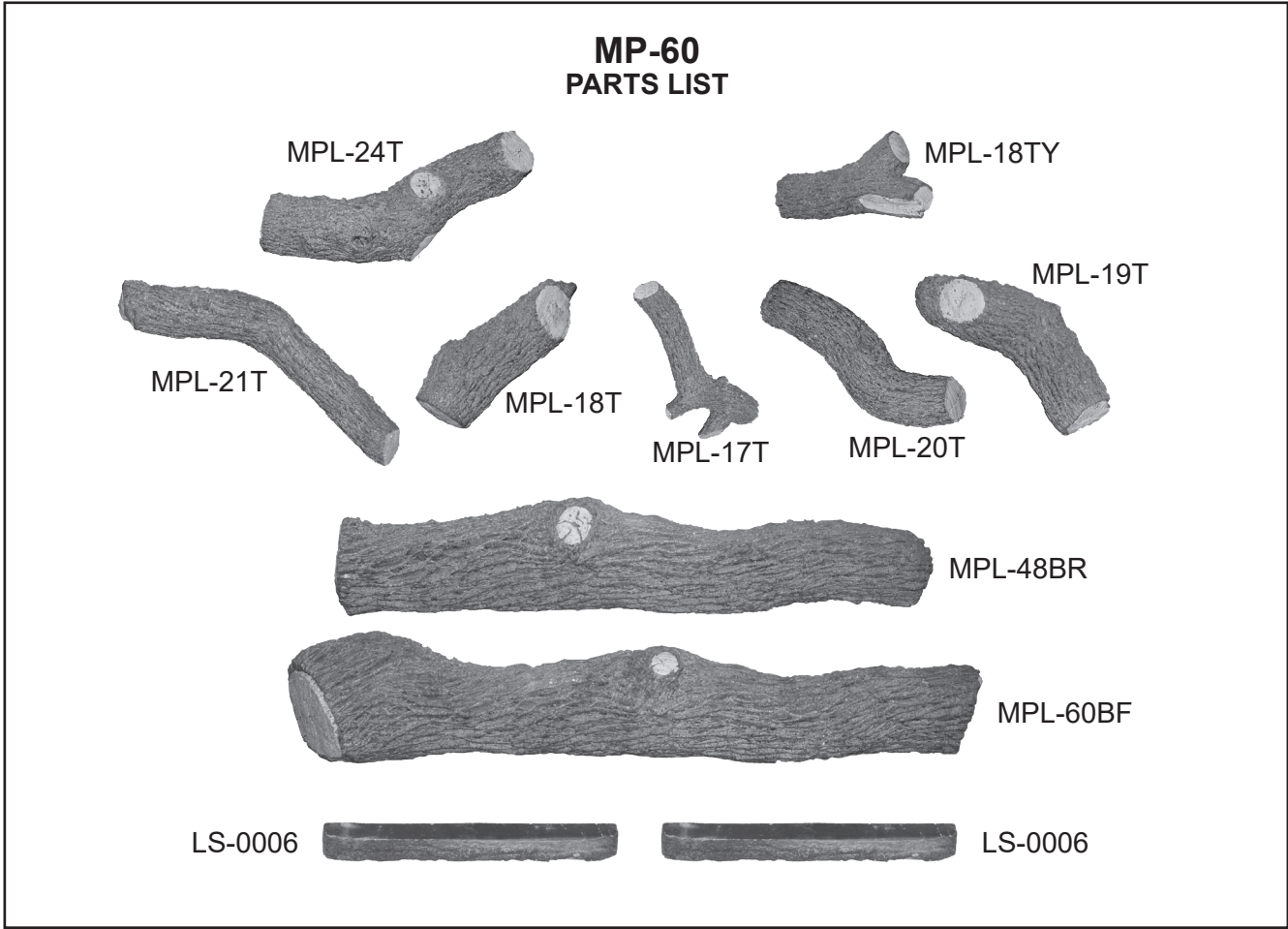

# INSTALLATION

The Real Fyre burner system must be installed by a qualified professional service technician. Instructions must be followed carefully to ensure proper performance and full benefit from the burner system. **Check to be sure the burner system is designed and labeled for the type of gas (natural or propane gas) supplied to fireplace. Fireplace floor must be level, clean, and smooth (see FIREPLACE SAFETY INFORMATION section).**

**WARNING:** Failure to position the parts in accordance with these diagrams or failure to use only parts specifically approved with this appliance may result in property damage or personal injury.

REFER TO THE PARTS LIST WHEN FOLLOWING INSTALLATION INSTRUCTIONS. 48" burner model shown here.

## BURNER INSTALLATION

1. MAKE SURE FIREPLACE GAS SUPPLY IS TURNED OFF.
2. Locate the gas-supply stub inside the fireplace and remove the cap, if attached (reference Fig. 12-1).

**CAUTION:** When removing the cap, make sure the stub does not turn, loosening the connection inside the wall.

3. Remove the small adapter connected to the flex connector (if equipped), and set aside (do not use). Attach the open end of the flex connector to the existing adapter on the rear of the burner valve. Tighten securely. See Fig. 12-1.

4. Place the burner system in the fireplace. Center the burner from left to right in the fireplace.

5. **Be sure gas to the fireplace is off.** Remove the large adapter connected to the other end of the flex connector. Attach the adapter to the gas-supply stub using a pipe compound resistant to all gasses. Tighten securely. Then attach the open end of the flex connector to the adapter. Tighten securely. See Fig. 12-1.

6. **LEAK TEST:** Turn on the fireplace gas supply, and test at all connections for leaks using the appropriate soapy water solution. If bubbles appear, a leak is present. Turn off the gas and tighten at all connections. Repeat until no leaks are present. If a leak persists, turn off the gas supply and contact the local gas company or dealer. **NEVER USE A FLAME TO CHECK FOR LEAKS.**

7. At this stage the remote batteries are to be installed (if applicable). Reference the INSTALLING/REPLACING BATTERIES section for details.

### 8. Remote Receiver Install (if equipped)

If this unit was shipped with a remote, read and follow the separate remote instructions (packed with remote) for complete remote installation. Reference Fig. 12-3.

**Important:** Ensure that the receiver is a minimum of 6" from the burner, and its wires remain away from the burner, valve, and flame at all times.

### 9. Decorative Heat Shield (if equipped)

Ensure the remote receiver is properly installed (with the plastic cover over it). Then place the decorative heat shield over the remote receiver. See Fig. 12-3.

**CAUTION:** THE REMOTE RECEIVER AND DECORATIVE HEAT SHIELD WILL BE HOT DURING AND AFTER OPERATION.

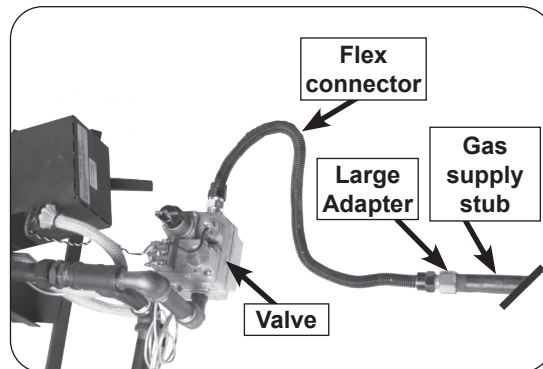

Fig. 12-1 Connect gas supply

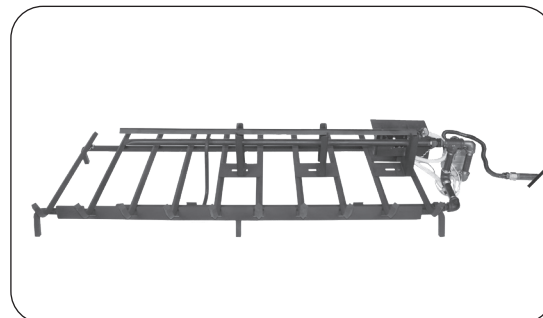

Fig. 12-2 Burner orientation

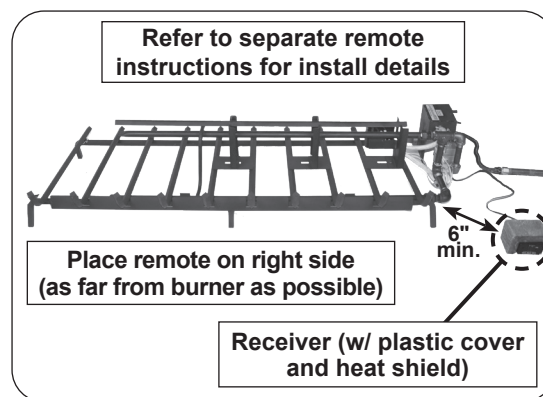

Fig. 12-3 Install remote receiver and heat shield (if equipped)

Installation continued on next page

## HEAT SHIELD PLACEMENT

### TO PREVENT DAMAGE AND FAILURE:

IT IS CRITICAL THAT THE HEAT SHIELD BE PLACED CORRECTLY OVER THE VALVE PRIOR TO OPERATION.

### TO PREVENT OVERHEATING:

Place the heat shield over the valve as shown in Fig. 13-1. It should rest flat above the valve.

Keep the area above and below the heat shield clear of decorative media or any other objects at all times.

**Important:** Ensure any lines/tubes/wires from the valve do not interfere with heat shield placement.

## LIGHTING TEST

Prior to proceeding with installation, perform a lighting test (see lighting instructions for lighting your burner). **Allow the unit to completely cool after testing.**

### IMPORTANT

For all valves, the air **MUST** be purged from the gas line before the pilot will light and burn properly. The time needed to purge will depend on the length of the gas line to the unit and the amount of time since the unit or gas line was last used. It may take several minutes before all the air is purged and the pilot will light and burn properly. Reference the LIGHTING INSTRUCTIONS section in this manual.

## LAVA COALS

Lava coals are supplied (with the mammoth pine log set) for decorative purposes. Follow the steps below.

1. Spread the lava coals on the floor of the fireplace, around the front and sides of the burner system (see Fig. 13-2).

**Note:** DO NOT place any lava coals on the burner system, behind it, on or within the heat shield (see Fig. 13-3).

If applicable, the lava coals may be placed around the remote receiver box. Leave the front of the box clear for control access.

**KEEP LAVA COALS AND ALL FOREIGN OBJECTS AWAY FROM THE PILOT ASSEMBLY, VALVE ASSEMBLY, AND HEAT SHIELD DURING MEDIA PLACEMENT AND AT ALL TIMES. SEE FIG. 13-3.**

Installation continued on next page

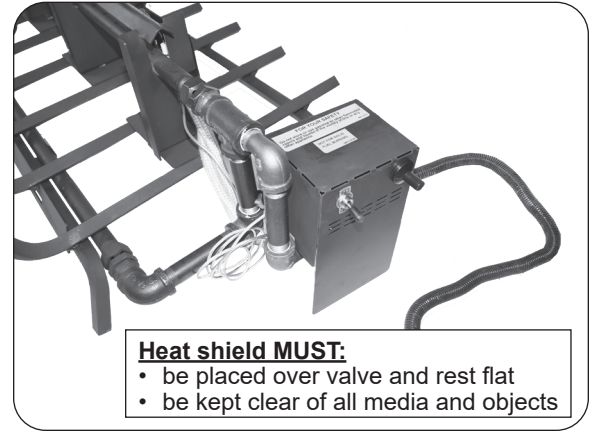

Fig. 13-1 Place heat shield

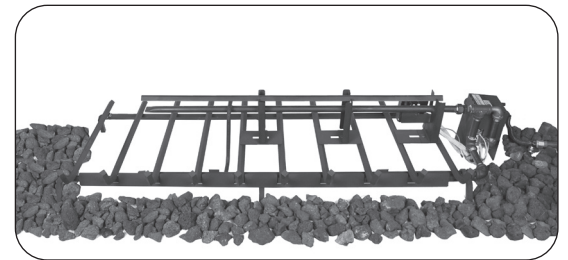

Fig. 13-2 Place lava coals

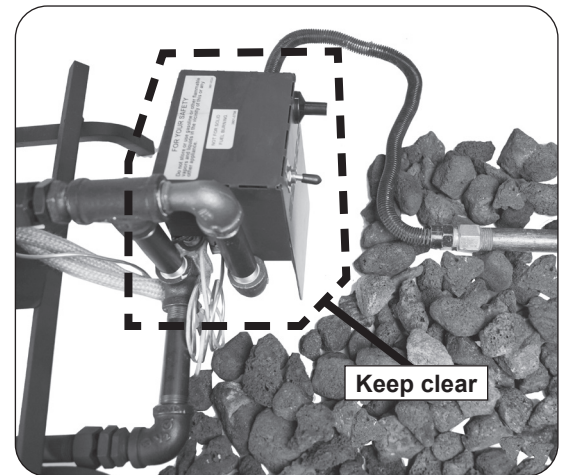

Fig. 13-3 Proper lava coals placement

## LOG SET PLACEMENT

- Read all safety warnings and important information in this manual to ensure proper placement.
- The logs are heavy and require two or more people to handle. Exercise extreme care during placement.

All models begin with the bottom log placement shown below. To complete log placement continue to the following section specific to your log set size.

### Common Placement Steps

Rear spacer logs provide a platform for rear bottom log (if applicable)

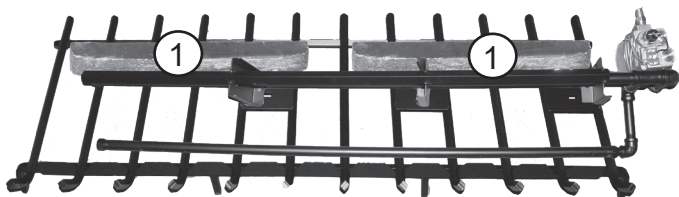

Place rear spacer logs as shown (if applicable - 48" and 60" models only).

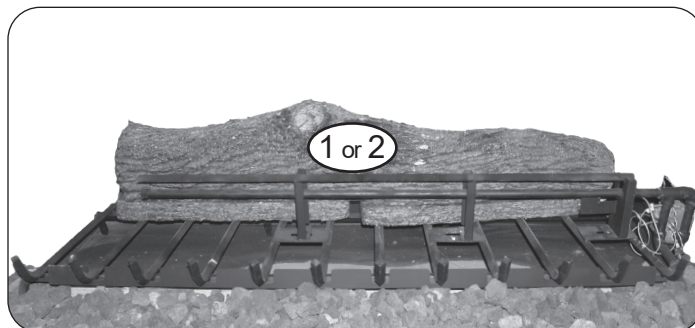

Place rear log as shown. It should rest on the two spacer logs, and forward up against the center burner.

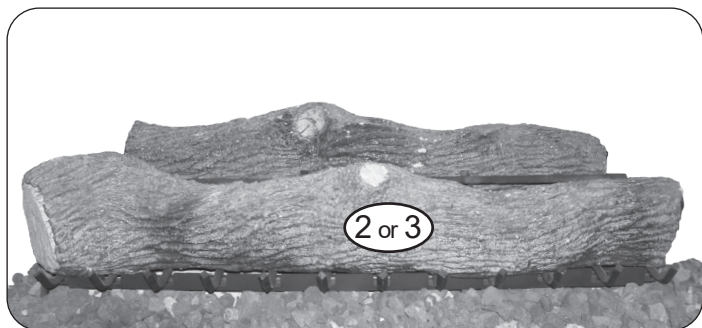

Place front log as shown.

**CONTINUE TO THE FOLLOWING SECTION SPECIFIC TO YOUR LOG SET SIZE.**

## INSTALLATION (cont.)

### 36" Log Sets

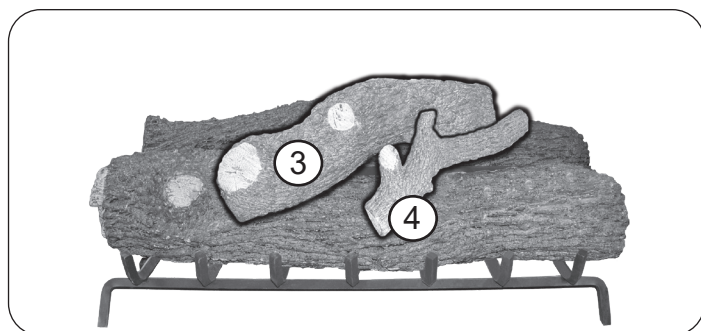

Place top logs 3-4 as shown.

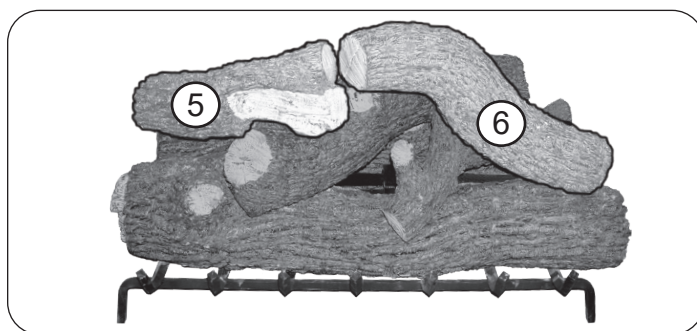

Place top logs 5-6 as shown.

### 48" Log Sets

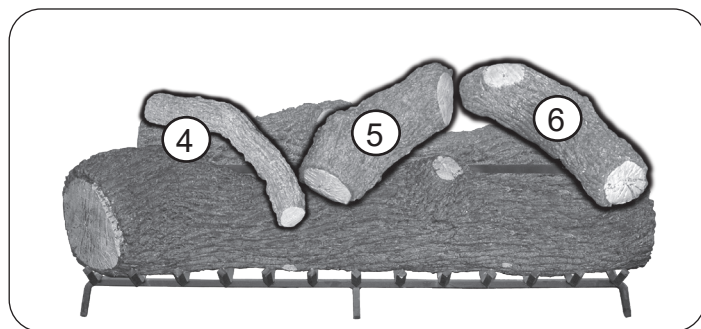

Place top logs 4-6 as shown.

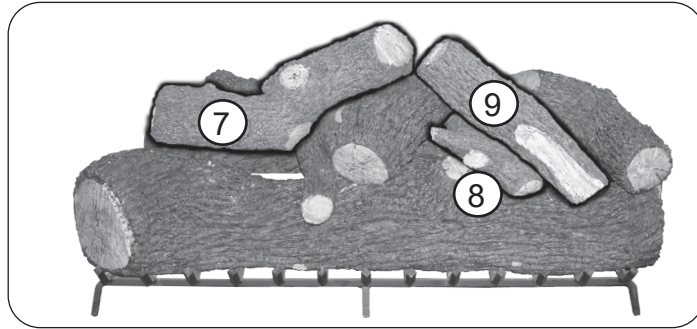

Place top logs 7-9 as shown.

### 60" Log Sets

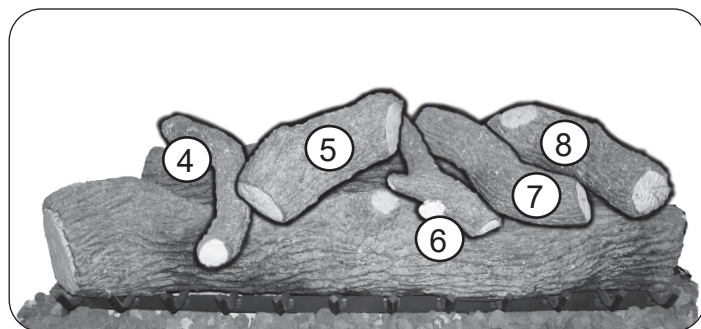

Place top logs 4-8 as shown.

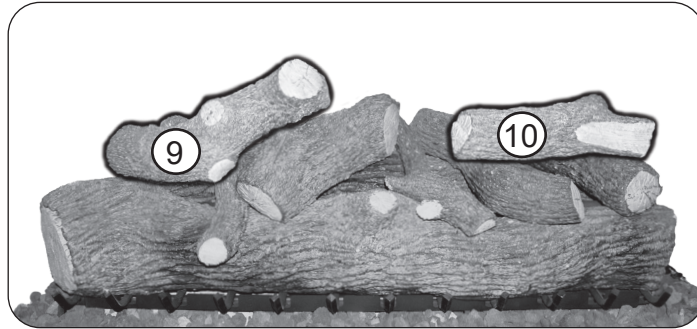

Place top logs 9-10 as shown.

**Important:** Adequate ventilation is absolutely necessary! Provided significant, noticeable sooting does not occur, some flexibility is possible in log placement to suit your individual preference. If you experience a continued accumulation of black carbon (soot) on your logs it is an indication of incomplete combustion and you should move the effected log(s) so as to minimize the flame contact on the effected log(s). Read the instructions supplied with the log set completely and carefully.

**CAUTION:** BURN HAZARD! Logs will remain hot for some time after use. If you need to reposition any log to maintain the proper layout, use heat-resistant gloves or allow logs adequate time to cool before handling.

## INSTALLING/REPLACING BATTERIES (IF APPLICABLE)

**CAUTION:** Ensure the unit is connected to the gas line and has been tested for leaks before you insert batteries.

**CAUTION:** Turn off the remote and/or burner and allow the unit to completely cool prior to any battery replacements.

**Important:** Prior to inserting batteries, always apply a small amount of dielectric grease to both ends of each battery. This will ensure conductivity and prevent moisture from affecting the contact.

**Important:** **Low/dead batteries will affect burner system operation. Replace batteries any time the burner will not turn on.**

### REMOTE TRANSMITTER BATTERY

The remote transmitter requires one 12V battery to operate (included). Locate the transmitter, remove the lid (found on rear), and properly insert the new battery as marked. Re-secure the lid. See Fig. 16-1.

### REMOTE RECEIVER BATTERIES

**Important:** Be sure to replace the decorative heat shield over the receiver after battery replacement.

The remote receiver requires 4 AA batteries to operate (included). Locate the remote receiver and turn it over. Slide open the lid, and properly insert the new batteries as marked. See Fig. 16-2.

Replace the lid, then re-position the remote receiver in the fireplace. (Ensure the plastic cover is properly in place over the receiver.)



Fig. 16-1 Transmitter battery

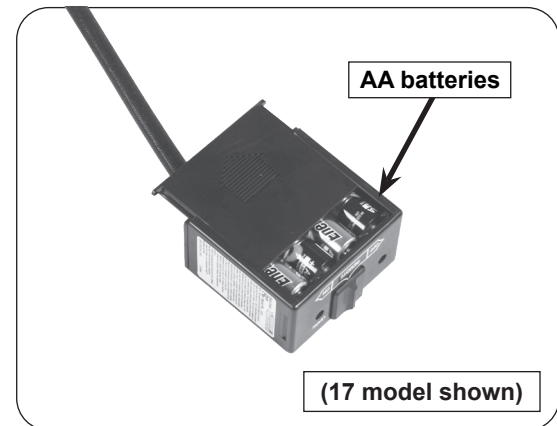

Fig. 16-2 Remote receiver batteries



## FOR YOUR SAFETY, READ BEFORE LIGHTING

**WARNING:** If you do not follow these instructions exactly, a fire or explosion may result causing property damage, personal injury or loss of life.  
Be cautious around all hot surfaces.

Do not use this appliance if any part has been underwater. Immediately call for a qualified professional service technician to inspect the appliance and to replace any part of the control system and any gas control that has been underwater.

The Real Fyre burner system has a pilot that can be lit by using the built-in piezo igniter switch on the burner, or by hand using a match or long-necked lighter. When lighting the pilot, follow these instructions exactly.

**BEFORE LIGHTING**, smell all around the burner area for gas. Be sure to smell next to the floor, as some gas is heavier than air and will settle on the floor. IF YOU SMELL GAS, FOLLOW THE INSTRUCTIONS ON P. 1.

Use only your hand to push in or turn the gas control knob. Never use tools. If the knob will not push in or turn by hand, don't try to repair it. Call a qualified professional service technician. Force or attempted repair may result in fire or explosion.

### LIGHTING THE PILOT

Locate the valve on the right side of the unit. To read the control knob, read the marking nearest the knob's pointer (see Fig. 17-1).

1. If the safety valve control knob is in the **PILOT** position, push in slightly on the knob and rotate it clockwise ↻ to the **OFF** position.
2. Release knob and wait five (5) minutes.
3. Turn safety valve knob counterclockwise ↻ to the **PILOT** position. (Only the pilot gas will flow when the knob is pushed in.)
4. Push and hold the safety valve knob fully in and push in the piezo igniter button (on heat shield) several times until the pilot lights.
5. Hold the safety valve knob in for approximately 60 seconds before releasing.
6. If the pilot does not stay lit, turn the safety valve knob clockwise ↻ to the full **OFF** position. Wait five (5) minutes, then repeat steps 3 through 5.

### IGNITING THE MAIN BURNER

With the pilot lit, turn the safety valve knob counterclockwise ↻ to the **ON** position. Switch the toggle switch control (on heat shield) to the **ON** position, and the burner will light.

### SHUTTING OFF THE MAIN BURNER

Switch the toggle switch control to the **OFF** position. The pilot will remain lit.

### SHUTTING OFF THE PILOT

Be sure the toggle switch control is **OFF** and depress and turn the safety valve knob clockwise ↻ to the **OFF** position.

### ADJUSTING THE PILOT

- a. The pilot flame should encircle the generator tip, and is preset at the factory (Fig. 17-2).
- b. If adjustment is necessary (Fig.17-1), turn the gas adjustment screw counterclockwise ↻ to increase the pilot flame, or clockwise ↻ to decrease the pilot flame.

If this unit was shipped with a remote, or if a remote system was installed later, read and follow the separate remote instructions to operate the burner remotely.

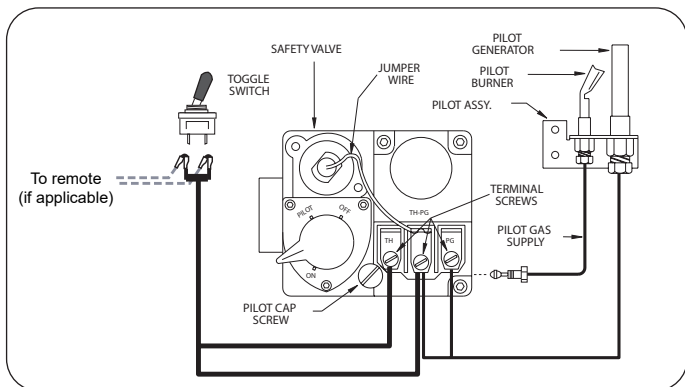
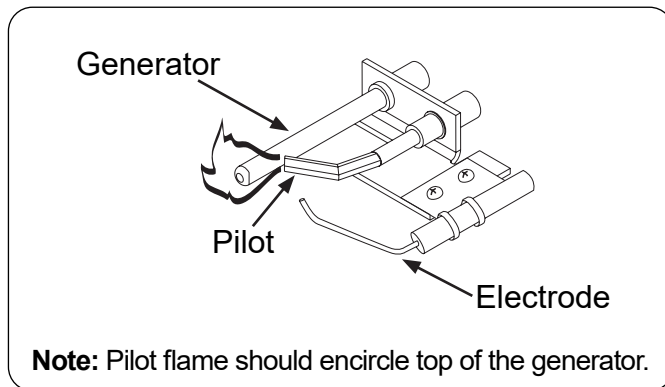

Fig. 17-1 Valve detail



**Note:** Pilot flame should encircle top of the generator.

Fig. 17-2 Lighting the pilot

## CLEANING AND SERVICING

**Note:** Discoloration is common on the grate after burning.

**Note:** Servicing may be necessary to ensure proper pilot operation and proper burn characteristics.

Always shut off the gas to the appliance while performing service work.

Allow the appliance to cool before servicing.

**Installation, service, and repair must be done by an NFI Certified or other qualified professional service technician. The appliance should be examined before use, and must be inspected at least annually to prevent burner shutdown, sooting, odors, etc. It must be checked for clean burning operation and proper pilot appearance, with the correct tools to service this unit. More frequent servicing may be required.** It is imperative that all control components and compartments, burner(s), air shutters, and circulating air passageways of the appliance be kept clean and free of all obstructions (as applicable).

In addition, a periodic examination and cleaning of the solid-fuel-burning fireplace venting system should be conducted by a qualified professional service technician.

**Any safety screen or guard removed for servicing must be replaced prior to operating this appliance.**

Replace batteries as needed. See INSTALLING/REPLACING BATTERIES section for details.

Verify proper operation after servicing.

If, after a period of use, the flames start to exhibit unusual shapes and behavior, or the burners fail to ignite smoothly, the burner may require cleaning or servicing. If this happens, it is recommended to contact the nearest dealer to get the appliance serviced.

**Do not remove the rating plates or the warning tags. These are an integral safety and identification component of this appliance.**

**We recommend following these instructions at the beginning of each fireplace season and as needed throughout the year, depending on your usage pattern and the environmental conditions in your home. More frequent cleaning and maintenance may be necessary when burning propane gas than with natural gas.**

### SYNCING THE REMOTE SYSTEM (if applicable)

Ensure the burner system is off and completely cool.

Locate the 3-position switch on the remote receiver and slide it to the **REMOTE** position. Use the tip of a pen or a wire clip to push the **LEARN** button and release. See Fig. 19-1. A beep will be heard. Then press and hold the **ON** or **ON/HI** button on the remote transmitter; a series of beeps should be heard. The remote system is now synced. Refer to the LIGHTING INSTRUCTIONS to test.

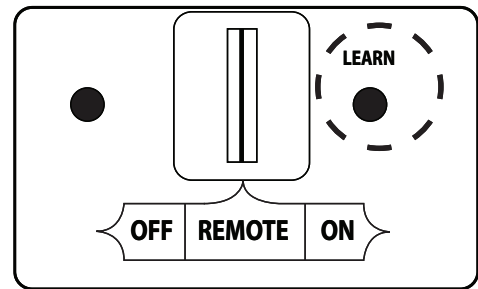

Fig. 19-1 Remote receiver sync detail

### ADJUSTING AIR SHUTTERS

Burners are equipped with air shutters for the upper (except 60") and front burners. Adjust the size and color of the flame by opening (turn outward) or closing (turn inward) as shown in Fig. 19-2.

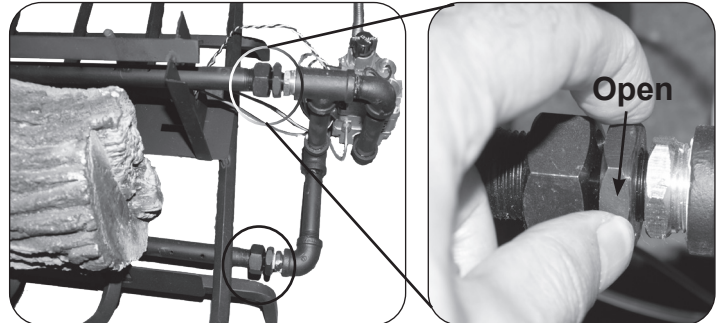

Fig. 19-2 Adjusting air shutter

## FLAME DESCRIPTION

Observe the flames. The main burner flames should be blue at the base and a combination of blue/yellow at the body and at the tips. They should be approximately 5-8" above the logs, with the center flame being the tallest. See 19-3 for example.

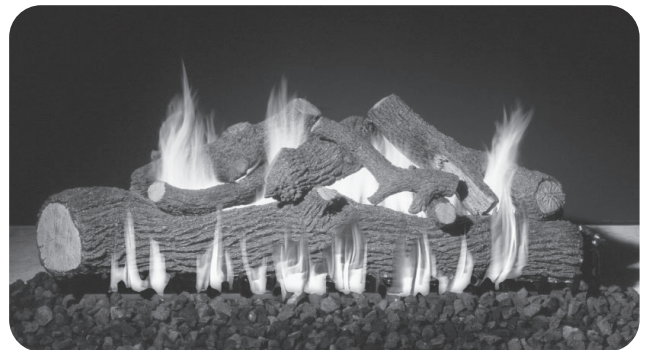

Fig. 19-3 Flame appearance

## TROUBLESHOOTING

POSSIBLE CAUSE	SOLUTIONS
<b>1 BURNER SHUTTING DOWN DURING OPERATION</b>	
<b>A.</b> Insufficient or excessive gas pressure	<b>A1.</b> Check gas pressure (Read D.- F. of IMPORTANT PRE-INSTALLATION AND FIREPLACE SAFETY INFORMATION section, & check with local gas company). <b>A2.</b> Other gas appliances may be on the same gas line, dropping gas pressure to log set. Check pressures with everything operating to ensure adequate pressure.
<b>B.</b> Log placement	<b>B.</b> Reference the LOG PLACEMENT section in this manual for recommended log positioning.
<b>C.</b> Flue area, fireplace, or damper dirty from soot	<b>C.</b> Clean around, above, and under damper thoroughly. Clean fireplace, removing loose material, including soot and creosote.
<b>D.</b> Fireplace too small for unit	<b>D.</b> Ensure minimum requirements are met (see SPECIFICATIONS section).
<b>E.</b> Pilot flame lifting off thermocouple/generator	<b>E.</b> Check gas pressure (see section A1).
<b>F.</b> Pilot (remote compatible)	<b>F.</b> Contact your dealer for instructions on replacement.
<b>G.</b> Blockages on burner	<b>G.</b> Vacuum any lava granules or material that may have fallen onto burner port area.
<b>2 PILOT WILL NOT LIGHT</b>	
<b>A.</b> Pilot flame lifting off thermocouple/generator	<b>A.</b> Check gas pressure (see Section 1, A1 of this table).
<b>B.</b> Electronic spark not lighting pilot	<b>B.</b> Check to ensure sparking when activated. <b>Note:</b> You may need to turn or press igniter several times to ignite pilot. See LIGHTING INSTRUCTIONS for your control valve.
<b>C.</b> Igniter electrode wire loose	<b>C.</b> Check wiring and reconnect any loose wiring.
<b>D.</b> Gas supply off/manual shutoff valve closed	<b>D.</b> Turn on gas supply or open manual shutoff valve.
<b>E.</b> Air in gas line	<b>E.</b> Bleed gas supply line and repeat LIGHTING INSTRUCTIONS until air is removed.
<b>F.</b> Pilot hood blocked	<b>F.</b> Check for debris or dirt / Clean pilot
<b>G.</b> Dead batteries (if applicable)	<b>G.</b> Replace batteries as needed.
<b>3 LOW FLAME HEIGHT</b>	
<b>A.</b> Gas pressure	<b>A.</b> Check gas pressure (see Section 1, A1 of this table).
<b>B.</b> Valve not fully open	<b>B.</b> Open valve fully.
<b>C.</b> Blockage or kink in flex connector kit, plumbing, or burner orifice	<b>C.</b> Clean out blockage. If flex connector is kinked, replace it.
<b>4 BURNER NOT BURNING EVENLY</b>	
<b>A.</b> Burner ports clogged	<b>A.</b> Clean burner ports.
<b>B.</b> Top burner lights; bottom burner has delayed ignition.	<b>B1.</b> Check gas pressure. Can be caused by too small of a gas line (see Section 1, A1 of this table). <b>B2.</b> Low propane tank level. Vacuum burner tube for soot blockage and fill propane tank.

## TROUBLESHOOTING (Cont.)

POSSIBLE CAUSE	SOLUTIONS
----------------	-----------

<b>5 ODORS</b>	
A. Gas leak	A. Shut off gas, if possible. Follow instructions on front page. Have a qualified professional installer or the gas company correct all leaks.
B. New home, new carpet, or new paint	B. When these odors are drawn into the fireplace, this may cause objectionable odors. Thoroughly ventilate the area before restarting your log set.
C. Damper not properly open, or closed	C. Ensure that damper is <u>fully</u> open.

<b>6 SMOKING AND/OR SOOTING</b>	
A. Poor draft or downdraft	A. Check for chimney blockage. Be sure chimney is at least 3' taller than anything within 10' of it in all directions. If not, consult a chimney sweep. A chimney cap or fan may help.
B. Damper not properly open, or closed	B. Ensure that damper is <u>fully</u> open.
C. Burner is positioned too close to front of firebox	C. Move burner system to the center of the firebox.
D. Improper media placement	D. See INSTALLATION section for proper media placement.
E. Air shutter(s) closed (if applicable)	E. Open air shutter(s) as needed.
F. Air shutter(s) blocked with debris (if applicable)	F. Vacuum debris away from air shutter(s).
G. Log placement	G. See solution in Section 1, B.
H. Using natural-gas burner on propane gas or propane burner on natural gas	H. If gas listed on nameplate does not match gas you are burning, shut down burner system immediately. Call dealer.
I. Adding any accessories to burner system	I. Shut down burner system and take off any accessories that do not belong with the system.

<b>7 PILOT WILL NOT STAY LIT</b>	
A. Valve won't hold	A. Contact your dealer for instructions on replacement.
B. Pilot hood not aimed at thermocouple/thermopile	B. Pilot hood bent; replace pilot or angle pilot hood properly so pilot flame hits thermocouple/thermopile.
C. Pilot line bent / kinked at connection to valve	C. Replace pilot line.
D. Thermocouple/thermopile is loose	D. Tighten thermocouple/thermopile nut at gas control valve. (Do not over tighten.)
E. Thermocouple/thermopile cracked or worn out	E. Replace thermocouple/thermopile.
F. Excessive down draft	F. Install chimney cap / Outside chimney too close to other peaks / Check chimney flue for proper height / Poorly designed chimney.

<b>8 BURNER WILL NOT TURN ON</b>	
A. Low/dead batteries in remote transmitter AND/OR switch/receiver box (if applicable)	A. Replace batteries as needed.

<b>9 FLAME AT AIR MIX / ORIFICE (PROPANE MODELS)</b>	
A. Burner ports clogged	A. Clean burner ports.
B. Gas pressure	B. Check gas pressure (see Section 1, A1 of this table).

# WARRANTY

## PETERSON VENTED DECORATIVE GAS APPLIANCE LIMITED WARRANTY

R.H. Peterson Co. ("RHP") warrants your Real Fyre® vented decorative gas appliance to be free from defects in material and workmanship. RHP vented refractory gas logs are warranted for **as long as the original purchaser owns them (lifetime) when used indoors and for THREE (3) YEARS when used outdoors.**

RHP vented fiber-ceramic blended gas logs are warranted for **FIVE (5) YEARS when used indoors and for THREE (3) YEARS when used outdoors.**

RHP **indoor** vented gas log burners and stainless steel burners (excluding controls) are warranted for **TEN (10) YEARS.**

RHP **outdoor** vented stainless steel burners (excluding controls) are warranted for **FIVE (5) YEARS.**

The **SPK-26** is warranted for **THREE (3) YEARS** and **APK-17** (including -17 valve) is warranted for **TWO (2) YEARS.**

All other valves, pilots, and controls are warranted for **ONE (1) YEAR** (excluding batteries).

RHP glass, gems, and nuggets are warranted for **TEN (10) YEARS.**

### A COPY OF YOUR SALES SLIP FOR PROOF OF PURCHASE IS REQUIRED

This warranty applies to the original purchaser for products which are installed in the United States or Canada and which are operated and maintained as intended for single family residential usage. This warranty is valid only with proof of purchase, commences on the date of purchase, and terminates (both as to original and any replacement products) on the anniversary date of the original purchase of the product per the above schedules.

This warranty covers defects in material and workmanship. This warranty **does not** cover parts which become defective as a result of negligence, misuse, use not in compliance with the Installation and Owner's Manual, accidental damage, improper handling, improper storage, improper installation, **lack of required routine maintenance** (as specified in the Installation and Owner's Manual), electrical damage, local gas impurities or failure to protect against combustible materials. Product must be installed (and gas must be connected) as specified in the Installation and Owner's Manual by a **qualified professional installer.** This warranty **does not** apply to rust, corrosion, oxidation, or discoloration unless the affected part becomes inoperable. RHP products including valves, pilots and controls, are designed and certified to be used as a system. Modifications to products which are not specifically authorized will void this warranty and could render the product to be unsafe. Burners, valves, parts, accessories, remotes, etc. used with this product must be RHP products or this warranty is void. Warranted items will be repaired or replaced at RHP's sole discretion. This warranty **does not** cover labor or labor related charges, except as provided by separate specific written programs from RHP. All repair work must be performed by a qualified professional service person and requires prior approval of RHP. RHP may require the defective product or part to be returned to the factory to determine the cause of failure. RHP will pay freight charges if the product or part is determined to be defective. This warranty does not cover breakage in shipment from our independent distributor to its customer if the damage is determined to have occurred during that shipment.

This warranty specifically excludes liability for **indirect, incidental,** or consequential damages. Some states and provinces do not allow the exclusion or limitation of incidental or consequential damages, so the above exclusion may not apply to you. This warranty gives you specified legal rights, and you may have other rights that vary from state to state or province.

For additional information regarding this warranty, or to place a warranty claim, contact the RHP dealer where the product was purchased.

When contacting your RHP dealer or the R.H. Peterson Co., please provide the following information:

- Your name, address, telephone number, e-mail
- Sales receipt showing where purchased and date purchased
- Model number, serial number of product, date code
- Relevant information: installer, additions, repairs, when defect was first noted

**TO REGISTER YOUR PRODUCT ONLINE GO TO: WWW.RHPETERSON.COM, AND CLICK ON PRODUCT REGISTRATION. THANK YOU FOR YOUR PURCHASE.**

<b>Quality Check</b>			<b>Date:</b> _____		
<b>Burner Orifices</b>	Nat.	L.P.	<b>Leak Test:</b> _____	<b>Model#:</b> _____	
<b>Main:</b>	_____	_____	<b>Burn Test:</b> _____	<b>Serial#:</b> _____	
<b>Other:</b>	_____	_____	<b>Gas Type:</b> <u>Nat. / L.P.</u>	<b>Air Shutter:</b> _____	
				<b>Inspector:</b> _____	